



SunnCamp



ICON AIR size 17

SunnCamp 2018

INTRODUCTION

For over 30 years SunnCamp has been manufacturing outdoor products including Caravan Awnings, Motor Awnings, Trailer Tents and Tents. Our aim is to produce the best range of meticulously designed, exceptionally well-made and fantastic value products that will give you and your family the best outdoor experience. All our products are made from specially developed fabrics and have a vast range of features and attention to detail.

CONTENTS

Page 3	Fabrics
Page 4	SunnCamp Air Volution – Pole Free Inflatable Pitching
Page 5	Specifications
Page 6-7	Enhance your SunnCamp Experience
Page 8-9	SunnCamp ICON AIR - Full Awning
Page 10-21	SunnCamp Air Volution Awnings
Page 22-27	SunnCamp Poled Awnings
Page 28 -38	SunnCamp Air Volution Motor Awnings & Poled Motor Awnings
Page 39-41	SunnCamp Air Volution Tents & Poled Tents
Page 42	SunnCamp Utility Tents/Windbreaks/Poled Annexes
Page 43	Glossary



FABRICS

All SunnCamp fabrics comply with the latest British Standard Flame Retardant Regulations

SunnCamp's ACE-TECH Fabric



Our **ACE-TECH** fabric comes in various weights and is coated with layers of a specific mix of PU waterproof coating which has been evenly and uniquely applied so that the fabric offers protection from the elements and UV light.

SunnCamp's PRO-TEK 300D Fabric



A super strength 300 denier high density fabric which has been developed by SunnCamp's technical team.

PRO-TEK 300D offers four times the tensile strength as standard 75D fabric and new improvements and technical developments have allowed our fabric to be specially woven and coated with layers of waterproof coating which have been evenly and uniquely applied so that the fabric keeps its ultra flexibility and softness, yet sits suitably in shape. **PRO-TEK 300D** has high tensile strength and offers increased protection from the elements and UV light.

Introducing SunnCamp's NEW 300D PRO-TEK Enhanced Roof Profile Fabric



Our new roof fabric further complements the appearance of our products and provides a homely ambience.

150D Oxford/150D Oxford Ripstop Fabric

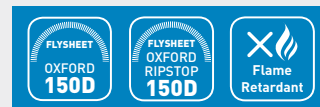

A high quality fabric (twice as thick as regular flysheets) providing improved protection from the weather and UV light. Our ripstop version has the same specification but has been woven using a special reinforcing technique where reinforcement threads are woven at regular intervals in a crosshatch pattern making the fabric more resistant to tearing.



AIR VOLUTION – POLE FREE INFLATABLE PITCHING

In place of conventional poles, SunnCamp's Air Volution products are pre-fitted with durable air tubes which are enclosed in a heavy duty double layer sleeve, providing an extremely secure and stable structure when inflated and guyed.

Setting up is easy...

Attach the inflator pump to the valves in the air tubes and pump until you reach the correct pressure of 7 psi. Close the valves and your product is ready for use. Air tubes should be inflated to 7 psi.

Air Volution Advantages

- Quick, simple and effortless pitching and take down
- Robust maintenance free inflatable tubes replace conventional poles
- Products can in most cases easily be erected by one person



SPECIFICATIONS

Standard Specification

- Waterproof and Fire Retardant Flysheet
- Taped seams
- Heavy duty zips
- Curtains on windows
- Colour coded poles and sleeves (poled items only)
- Pre attached guylines

Awning Standard Specification/Features

- Pump with gauge and dump valve (Air Volution models only – not included with annexes or inner tents)
- Storm buckles & straps (Air Volution models only)
- Rear pads: Rear pads to seal to caravan (except Swift Canopy)
- Draught skirt (except Swift Canopy and Protekta Awnings)

Motor Awning Standard Specification/Features

- Pump with gauge and dump valve (Air Volution models only – not included with annexes)
- Storm buckles & straps (Air Volution models only)
- Figure of 8 fixing kit

Tent Standard Specification/Features

- Pump with gauge and dump valve (Air Volution models only – not included with annexes or inner tents)
- Storm buckles & straps (Air Volution models only)
- Daylight panel
- Cable entry point and tidy system
- Twilight inner tents



LED LIGHTING SYSTEM Starter Pack (EL3001)

Ideal for: Inflatable or Poled Awnings, Motor Awnings & Tents

Includes:

- 2 x 1m LED light strips with magnets and tie cables
- 1 x 5m cable/1 x 3m cable/1 x 60cm cable/1 x 30cm cable
- 1 x remote control (with in line sensor)
- 1 x UK Plug (approx. 1m cable)
- 1 x 12V cigarette socket (approx. 3m cable)



**Illuminate
your
Awning/Tent**

LED LIGHT SLEEVES (DT0101)

**Suitable for all SunnCamp Air
Volution models (dual inflation)**

Pack comprises of 2 sleeves

- Recommended for use with: SunnCamp LED Lighting System [AC3001]& Add on Kit [AC3002]
- Sleeves Velcro onto inflatable storm bars
- LED Lights easily insert into sleeves via zipped PVC section
- Sleeve length 1 metre (approx.)

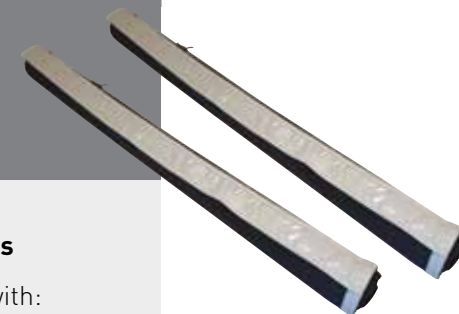

LED LIGHTING SYSTEM Add on Kit (EL3002)

Ideal for: Inflatable or Poled Awnings, Motor Awnings & Tents

Includes:

- 1 x 1m LED light strip with magnets and tie cables
- 1 x 3m cable
- 1 x 60cm cable
- 1 x 30cm cable



12V ELECTRIC PUMP (AC3000)

**Ideal for all
Air Awnings
and Air Tents**

- Powered by car 12V socket
- Can inflate up to 16 psi
- Cuts out at pre-set pressure
- Extra long 10m cable
- Two nozzle fittings



STORM BAR KITS

Storm Bar Kits to complement your awning are available for various Air Volution models.

Please ask your stockist for further information or email info@sunncamp.co.uk



ROOF LININGS

Roof Linings are available for some models. Please ask your stockist for further information or email info@sunncamp.co.uk



AWNING SEAL SET [AC71003]

Ideal for use with Porch Awnings

- Inflatable pads help seal awning to caravan
- Prevents draughts
- Improves fit of awning
- Reduces movement of awning

Improve the seal of awning to caravan



Internal



External

ALSO AVAILABLE:

- **Bespoke Breathable Groundsheets**
- **Bespoke Luxury Carpets**
- **Rear Poles**
- **Canopy Poles**
- **Storm Poles**
- **Wheel Arch Covers**

Ask your dealer for further information or contact SunnCamp direct on info@sunncamp.co.uk

ICON AIR® Full Awning

Maximum living space



ICON AIR - model shown size 11

Simple and effortless pitching and inflation



Single inflation

- Includes Pump** with gauge and dump valve
- Includes Storm Buckles & Straps**
- Includes Veranda Pole** x1
- Includes Draught Skirt**
- Includes AIR Flow** Zip In/Out Ventilation Panels

Available Sizes:

Size 11	Size 12	Size 13	Size 14	Size 15	Size 16	Size 17	Size 18
900 – 925cm	925 – 950cm	950 – 975cm	975 – 1000cm	1000 – 1025cm	1025 – 1050cm	1050 – 1075cm	1075 – 1100cm

Layout:

Size: 900-975cm (Size 11-13)

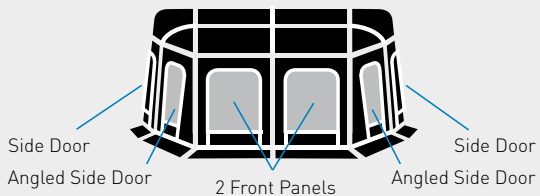

Size: 975-1100cm (Size 14-18)

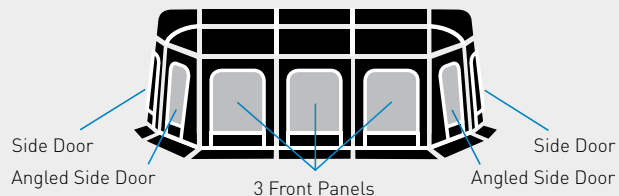

If you need guidance on the correct size awning for your caravan, please contact your SunnCamp Dealer/Stockist.

ICON AIR® Full Awning Size 17 – Approximate weight 30kg including all zip out panels. We recommend you remove these when feeding awning through your caravan rail.

ICON AIR ANNEXE Approximate weight 7.5kg



Add space with our optional **ICON AIR ANNEXE**

ICON AIR with optional Annexe



Internal view

Innovative design, quality construction ...

Floor Plan - showing Optional Annexe

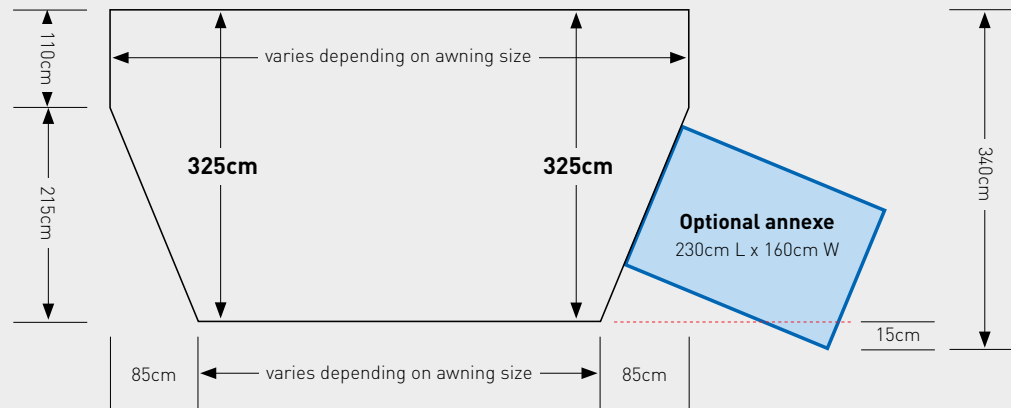

Features:

- Air Volution Single Inflation
- Secondary mesh on side doors
- Zip in mesh panels for all other panels
- LED light pockets (for optional LED light system)
- Removable panels (all with veranda option) dependant on size (900 – 975cm = 4 panels, 975 – 1100cm = 5 panels)
- Curtains on all windows
- External peggable mud wall for extra weather protection
- Draught skirt with ventilation panels
- Pre-attached storm buckles and webbing straps
- Pre-attached guylines

ADVANCE AIR MIDWAY (SF8031)

Compatible with **ADVANCE AIR ANNEXE** (SF8036)

Features:

- Compatible with Advance Air Annexe – will fit onto either side of awning
- Interchangeable, removable side panels with secondary mesh
- Veranda option on side panels (veranda pole optional extra)
- Removable front panel with door options
- SunnCamp's enhanced roof profile (ERP)
- Windows with integrated mesh options
- Curtains on all windows
- Zipped ventilation under integral canopy
- Vertical storm pole pockets
- **Height range: 235cm – 250cm**

Zip on/off front canopy available as an optional extra

Our Advance Air Midway has the silhouette of a traditional awning and is manufactured utilizing SunnCamp's **PRO-TEK 300D** fabric together with our highly regarded Air Volution air frame technology, providing effortless comfort with unsurpassed quality and features.

A zip on/off Sun Canopy (SF8034) with a projection of approximately 1.8m, is available to purchase as an optional extra and simply zips onto the front of the awning. The Sun Canopy also has beading so that it can be attached directly to your caravan as an option.

Floor Plan

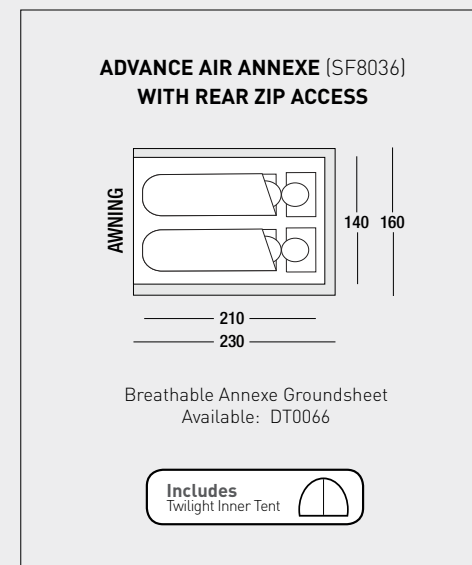
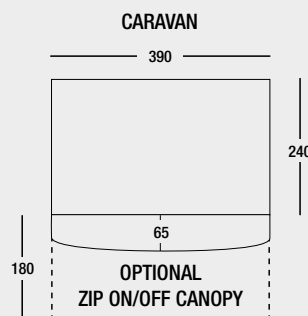

Includes Pump with gauge and dump valve

Includes AIR Storm Bars x3

Includes Rear Weather Poles

Includes Storm Buckles & Straps

Includes Vertical Storm Pole

Includes Draught Skirt

	Midway	Annexe
Approx. Pack Size:	79cm x 38cm	69cm x 26cm
Approx. Weight:	25kg	7.5kg
Air Storm Bars	x 3	N/A



ADVANCE AIR MIDWAY

... effortless comfort with unsurpassed quality and features



ADVANCE AIR MIDWAY



ADVANCE AIR MIDWAY



LED Light System



ADVANCE AIR MIDWAY

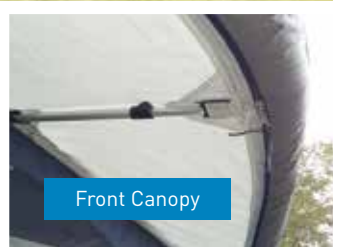

Front Canopy



Optional Annexe

INCEPTOR AIR PLUS 450 (SF7856)

INCEPTOR AIR PLUS 390 (SF8037)

INCEPTOR AIR PLUS 330 (SF8038)

Compatible with AIR ANNEXE PLUS (SF7813)

Compatible with APARTAIR (SF8008-R/SF8008-L)

Features:

- Compatible with Air Annexe Plus – will fit onto either side of awning
- Compatible with ApartAIR – left and right fit available (390 and 330 models only)
- Interchangeable, removable side panels with secondary mesh
- Removable front panels
- Two zip in/out airflow panels (1 x front right/1 x front left)
- Veranda option on all panels
- SunnCamp's enhanced roof profile (ERP)
- Window lights in roof (with curtains)
- Curtains on all windows
- Vertical storm pole pockets
- **Height range: 235cm – 250cm**

See page 21 for available accessories to complement your awning

	450	390	330	Annexe	ApartAIR
Approx. Pack Size:	79cm x 44cm	79cm x 43cm	79cm x 42cm	65cm x 25cm	72cm x 28cm
Approx. Weight:	27kg	23kg	21kg	7.5kg	12kg

With panoramic views from the inside and its superb appearance from the outside, our Inceptor genre comprises of three models. All models are compatible with our Air Annexe Plus, offering extra storage or sleeping space.

Our 390 and 330 models are compatible with our ApartAIR which is available in a left or right fit, your awning will take either or both creating amazing extra living space.

All three models are manufactured utilizing SunnCamp's **PRO-TEK 300D** together with our reputable Air Volution air frame technology

Floor Plans

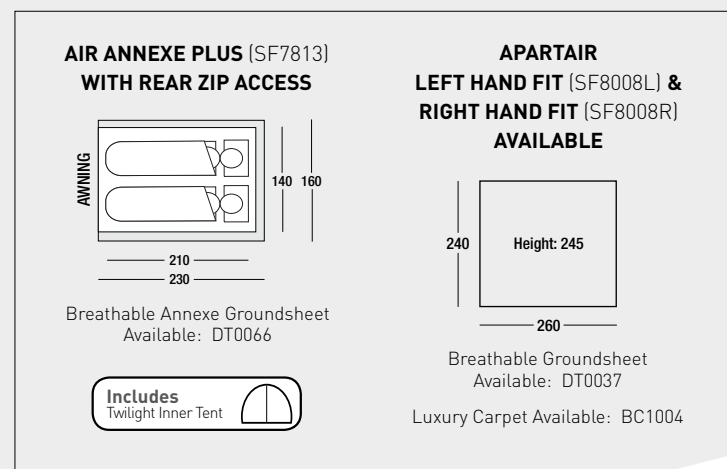
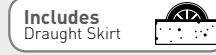
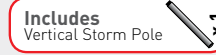
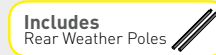
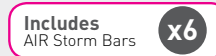
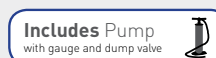
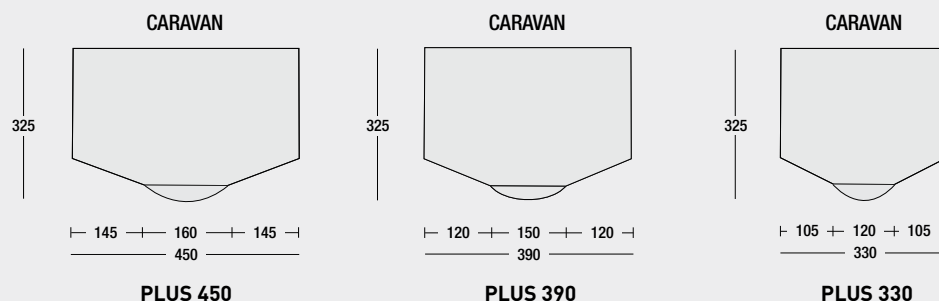



INCEPTOR AIR PLUS 330



INCEPTOR AIR PLUS 390

... panoramic views from the inside and its superb appearance from the outside...



Internal view



APARTAIR right fit

ULTIMA AIR GRANDE 390 (SF7861)

Compatible with ANNEXE (SF7813)

ULTIMA AIR SUPER DELUXE 390 (BLUE - SF7887)

Compatible with ANNEXE (SF7889)

ULTIMA AIR SUPER DELUXE 280 (BLUE - SF8039)

Compatible with ANNEXE (SF7889)

Features:

- 390 Ultima Air Grande compatible with Air Annexe Plus – will fit onto either side of awning
- Ultima Air Super Deluxe 390/280 Compatible with Ultima Air Annexe Super Deluxe – will fit onto either side of awning
- Interchangeable, removable side panels with secondary mesh
- Roll up front panels with canopy option
- Veranda option available (Grande includes 1 x veranda pole)
- SunnCamp's enhanced roof profile (ERP)
- Curtains on all windows
- Vertical storm pole pockets
- Optional extra zip on front canopy (available for all models)
- **Height range: 235cm – 250cm**

See page 23 for details of optional sun canopy

Optional Inner Tent Available (SF9600)

	Grande 390	Super Deluxe 390	Super Deluxe 280	Annexe
Approx. Pack size:	79cm x 44cm	79cm x 37cm	79cm x 33cm	62cm x 21cm
Approx. Weight:	26kg	22kg	18kg	10kg
Air Storm Bars	x 6	x 6	x 4	N/A
Veranda Pole	x 1	✗	✗	N/A

There's an Ultima Air model suitable for everyone. Choose from our Grande 390, 390 or 280 model. Packed with features and with bespoke carpets and groundsheets available as an optional extra, these awnings continue to be a firm favourite.

Floor Plans

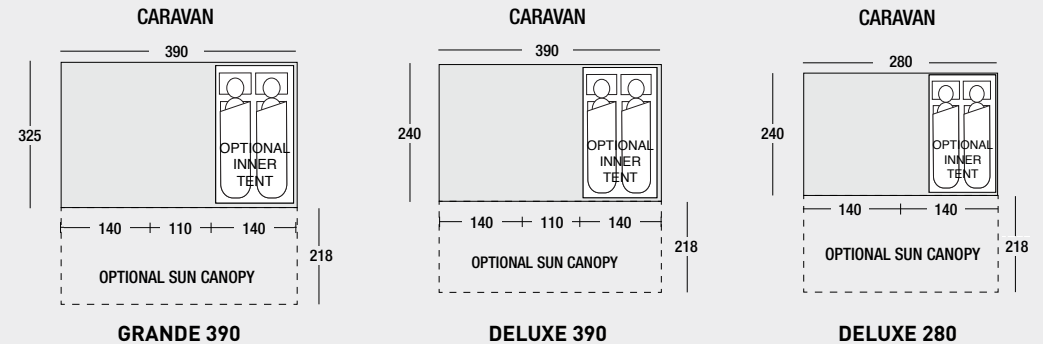

Includes Pump with gauge and dump valve

Includes AIR Storm Bars

Includes Rear Weather Poles

Includes Storm Buckles & Straps

Includes Draught Skirt

ULTIMA AIR ANNEXE SUPER DELUXE (SF7889) WITH REAR ZIP ACCESS

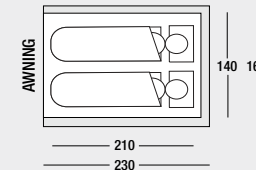

Breathable Annexe Groundsheet Available: DT0066

Includes Twilight Inner Tent



ULTIMA AIR SUPER DELUXE 390

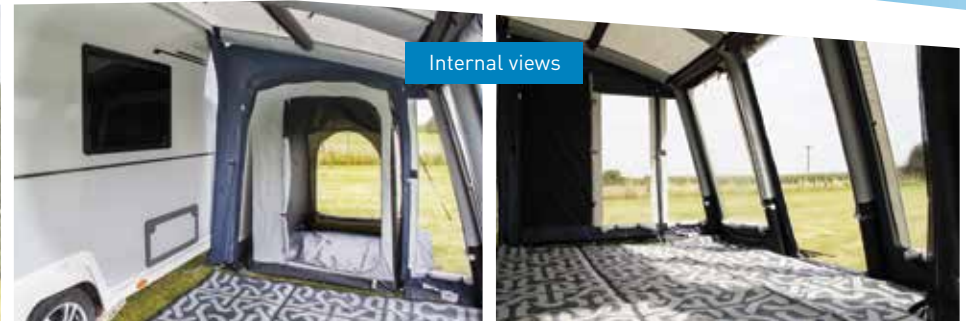

Internal views



Utilize SunnCamp's LED Lighting System to illuminate your awning



ULTIMA AIR GRANDE 390



ULTIMA AIR SUPER DELUXE 390 shown with Annexe

GLOBE AIR 350 (SF7859)

Compatible with GLOBE AIR ANNEXE PLUS (SF7860)

Features:

- Compatible with Globe Air Annexe – will fit onto either side of awning
- Interchangeable, removable side panels with secondary mesh
- Removable front panel/s
- Veranda option on front and side panels
- SunnCamp's enhanced roof profile (ERP)
- Vertical storm pole pockets
- **Height range: 235cm – 250cm**

See page 21 for details of optional extras

	350	Annexe
Approx. Pack size:	79cm x 35cm	69cm x 22cm
Approx. Weight:	22kg	7.5kg
Aluminium Roof Bars	x 3	N/A

SunnCamp's Globe Air 350 porch awning offers the simplicity and reliability of our successful Swift Range of products but is manufactured utilizing SunnCamp's **PRO-TEK 300D** fabric with additional features and an increased depth of 280cm to enable the use of an optional annexe.

A zip on/off Sun Canopy is provided which can be zipped onto the front of this awning alternatively, as an option, the canopy comes with beading and can be attached directly to your caravan.

Floor Plan

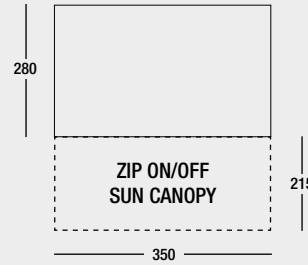

Includes Pump with gauge and dump valve

Includes Veranda Pole

Includes AIR Storm Bars **x3**

Includes Vertical Storm Pole **x1**

Includes Rear Weather Poles

Includes Draught Skirt

Includes Storm Buckles & Straps

GLOBE AIR ANNEXE (SF7860) WITH REAR ZIP ACCESS

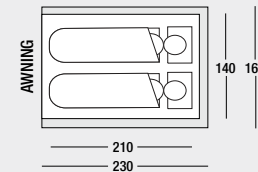

Breathable Annexe Groundsheet Available: DT0066

Includes Twilight Inner Tent



GLOBE AIR 350

.... COMPLEMENT YOUR SUNNCAMP AWNING WITH OUR AWNING WINDBREAK



AWNING WINDBREAK

[SF7838]

Compatible
with all
SunnCamp
Porch
Awnings

Features:

- Beading to attach to caravan
- Aluminium poles
- **Size 500 x 140cm approx.**
- **Pack size: 57x15cm/Weight 2.9kg approx.**



GLOBE AIR 350 - shown with front Canopy



GLOBE AIR 350 - shown with optional GLOBE Annexe



SWIFT AIR 390 (SF7817)
SWIFT AIR 325 (SF7763)
SWIFT AIR 260 (SF7764)
SWIFT AIR 220 (SF7809)

Features:

- Roll up front door with canopy option (Poles optional extra)
- Curtains on all windows
- Air flow side doorways
- Centre pocket for optional roof pole
- Vertical storm pole pocket (390 model only)
- **Height Range: 235 - 250cm**

Complement your awning with our luxury carpet

	390	325	260	220
Approx. Pack size:	79cm x 32.5cm	69cm x 31cm	65cm x 30cm	64cm x 29cm
Approx. Weight:	13kg	11kg	10kg	8kg
Air Storm Bars	x 3	x 1	✗	✗

Easy to erect, stylish and fantastic value for money, our Swift Air is available in four sizes.

All models have air flow side doorways and a roll up front door with canopy option.



SWIFT AIR 260

Floor Plans

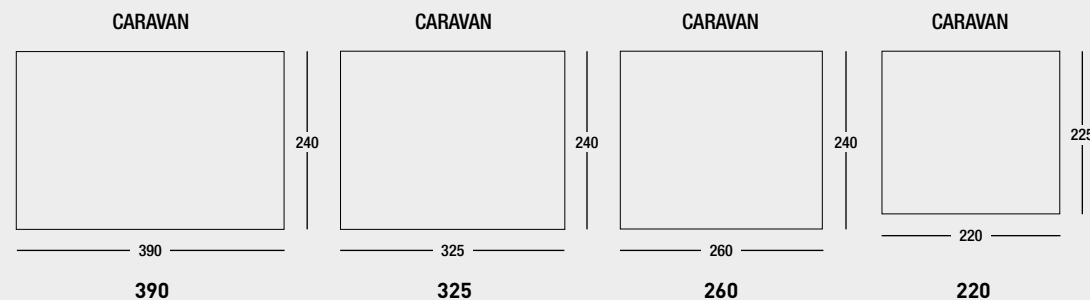

Includes Pump with gauge and dump valve

Includes Storm Buckles & Straps

Includes AIR Storm Bars x3 390

Includes Vertical Storm Pole 390

Includes AIR Storm Bars x1 325

Includes Draught Skirt

See page 21 for details of optional extras

SWIFT AIR 220



Easy to erect,
stylish and
fantastic
value for
money ...

Internal view



SWIFT AIR 390



SWIFT AIR 325



SWIFT AIR 390



ULTIMA AIR LITE 390 (SF 8041)

Features:

- Roll up front panels with canopy option (Poles optional extra)
- Curtains on all windows
- Optional inner tent available (SF7024)
- **Height Range: 235 - 250cm**
- **Pack Size: 78 x 32cm/Weight 16.3kg approx.**

Includes Pump
with gauge and dump valve

Includes AIR Storm Bars **x3**

Includes Storm Buckles & Straps

Includes Draught Skirt

Utilize our optional extra inner tent for sleeping or storage space

Floor Plan

CARAVAN

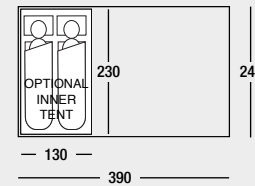

ULTIMA AIR LITE 390

DASH AIR 260 (SF7820)

DASH AIR 220 (SF7893)

Features:

- Roll up front door with canopy option (Poles optional extra)
- Curtains on all windows
- Centre pocket for optional roof pole
- **Height Range: 235 - 250cm**
- **260 Pack Size: 64 x 29cm/Weight 9.6kg approx.**
- **220 Pack Size: 63 x 28cm/Weight 7.6kg approx.**

Includes Pump
with gauge and dump valve

Includes Storm Buckles & Straps

Includes Draught Skirt

Floor Plans

CARAVAN

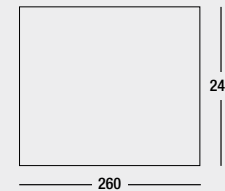

260

CARAVAN

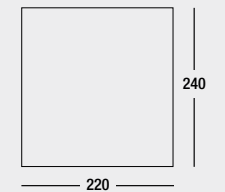

220

220

Our Dash Air awning is manufactured in our **75D ACE-TECH** fabric, incorporates our proven Air Volution technology with a front panel that can be rolled up or used as a canopy when utilized with our optional canopy pole set.



DASH AIR 260

OPTIONAL EXTRAS - Air Volution Awnings

12V Pump
available
See page 6

Model	Luxury Awning Carpet	Breathable Groundsheet	Rear Poles	Veranda Pole	Additional Air Storm Bars	Additional Alu Roof Pole	Canopy Pole Set	Annexe	Vertical Storm Pole	Inner Tent	Roof Lining	Sun Canopy	Awning Windbreak
Advance Midway	BC1008	DT0038	✓ Included	DT0077	SF7790 (x2)	DT0077	✓ Included	SF8036	✓ Included	N/A	SF4008	SF8034	SF7838
Inceptor Air 450	BC1013	DT0060	✓ Included	✓ Included	SF7891 (x3)	N/A	N/A	SF7813	✓ Included	N/A	SF4001	N/A	SF7838
Inceptor Air 390	BC1010	DT0055	✓ Included	✓ Included	SF7787 (x3)	N/A	N/A	SF7813	✓ Included	N/A	SF4002	N/A	SF7838
Inceptor Air 330	BC1012	DT0061	✓ Included	✓ Included	SF7892 (x3)	N/A	N/A	SF7813	✓ Included	N/A	SF4003	N/A	SF7838
Ultima Air Grande 390	BC1009	DT0065	✓ Included	✓ Included	N/A	N/A	DT0032	SF7813	DT0052	SF9600	SF4004	SF8003	SF7838
Ultima Air Super Dlx 390	BC1008	DT0038	✓ Included	DT0091	N/A	N/A	DT0032	SF7889	✓ Included	SF9600	SF4005	SF8003	SF7838
Ultima Air Super Dlx 280	BC1005	DT0042	✓ Included	DT0091	N/A	N/A	DT0032	SF7889	✓ Included	SF9600	SF4006	SF8002	SF7838
Globe Air 350	BC1015	DT0063	✓ Included	DT0091	N/A	N/A	✓ Included	SF7860	✓ Included	N/A	N/A	✓ Included	SF7838
Swift Air 390	BC1008	DT0038	DT0052	N/A	SF7789 (x2)	DT0091	DT0032	N/A	✓ Included	N/A	N/A	N/A	SF7838
Swift Air 325	BC1006	DT0053	DT0052	N/A	SF7788 (x1)	DT0091	DT0032	N/A	N/A	N/A	N/A	N/A	SF7838
Swift Air 260	BC1004	DT0037	DT0052	N/A	SF7786 (x2)	DT0091	DT0032	N/A	N/A	N/A	N/A	N/A	SF7838
Swift Air 220	BC1003	DT0046	DT0052	N/A	SF7785 (x2)	DT0091	DT0032	N/A	N/A	N/A	N/A	N/A	SF7838
Dash Air 260	BC1004	DT0037	DT0052	N/A	SF7786 (x2)	DT0091	DT0032	N/A	N/A	N/A	N/A	N/A	SF7838
Curve Air 390	BC1008	DT0038	DT0052	N/A	SF7847 (x3)	N/A	DT0032	N/A	N/A	SF7024	N/A	N/A	SF7838
Icon Air	YES*	N/A	N/A	DT0091	N/A	N/A	N/A	SI1000	DT0052	N/A	N/A	N/A	N/A
Icon Air Annexe	N/A	DT0066	N/A	N/A	N/A	N/A	DT0032	N/A	N/A	N/A	N/A	N/A	N/A

* Contact your dealer or email SunnCamp on info@sunncamp.co.uk

SWIFT DELUXE 390 [SF7831]

SWIFT DELUXE 325 [SF7769]

SWIFT DELUXE 260 [GREY-SF7803/BLUE-SF7845]

SWIFT DELUXE 220 [GREY-SF7802/BLUE-SF7844]

Features:

- Front door with canopy option (Poles optional extra)
- Curtains on all windows
- Two side doorways (390 and 325 only with airflow doorways)
- Centre pocket for optional roof pole
- Steel and fibreglass frame
- **Height Range: 235 - 250cm**

Breathable
groundsheets &
luxury carpets
available for all
porch awnings



SWIFT DELUXE 325

	390	325	260	220
Approx. Pack size:	79cm x 26cm	79cm x 24cm	78cm x 22cm	78cm x 21cm
Approx. Weight:	11.5kg	7.7kg	6.8kg	6.3kg
Alu Roof Poles	x 3	✗	✗	✗

Simple, practical, reliable and stylish, our illustrious range of SWIFT DELUXE AWNINGS come in a variety of sizes.

All sizes are available in our grey/black colourway and our 260 and 220 models are also available in our blue/grey colourway.

Floor Plans

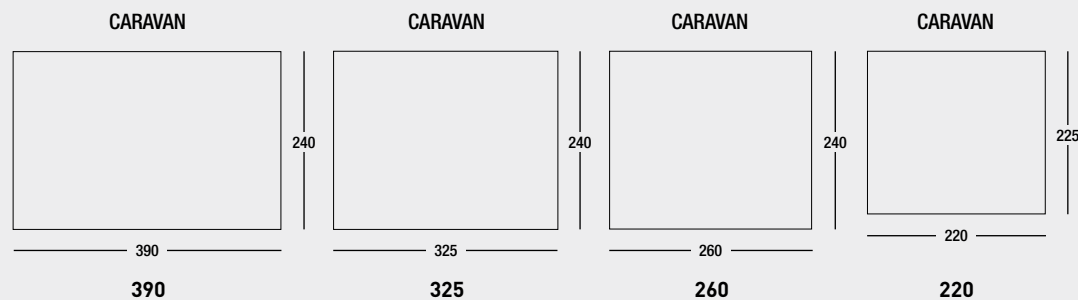

Includes
Roof Poles **x3** 390

Includes
Draught Skirt



SWIFT DELUXE 260



SWIFT DELUXE 390



Internal view

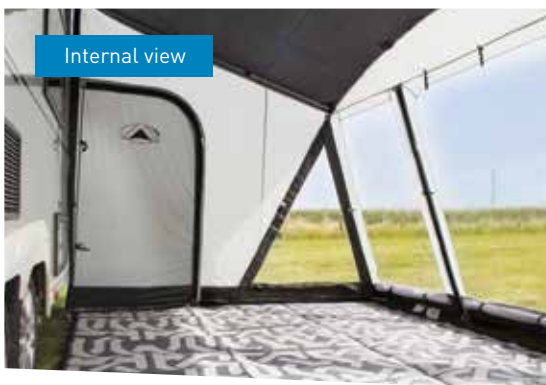

Simple, practical, reliable and stylish ...

SUNSHIELD UNIVERSAL SUN CANOPY 390

[SF8003]

SUNSHIELD UNIVERSAL SUN CANOPY 280

[SF8002]

SUNSHIELD UNIVERSAL SUN CANOPY 240

[SF8001]

Features:

- Attaches directly to caravan
- Three sizes available
- Maximum front height 200cm



	390	280	240
Product Dimensions	390cm x 218cm	280cm x 218cm	240cm x 218cm
Approx. Pack size:	65cm x 11cm x 11cm	65cm x 10.5cm x 10.5cm	65cm x 10cm x 10cm
Approx. Weight:	4.9kg	3.7kg	3.4kg

A simple sun canopy, with beading, which may be used on its own by fitting directly onto your caravan.

Our 390 and 280 models are also compatible with our 2017/2018 Ultima Air Grande 390, Ultima Air Super Deluxe 390 and Ultima Air Super Deluxe 280 awnings and zip onto the front of each awning to offer an additional awning sun canopy.

ULTIMA CLASSIC 390 (SF7828)

ULTIMA CLASSIC 260 (SF7829)

Features:

- Two side airflow doorways
- Curtains on all windows
- Roll up front panels with canopy option (Poles optional extra)
- Sleeps two with optional inner tent available (SF7024)
- Steel and fibreglass frame
- **Height Range: 235 - 250cm**

Check out optional extras available on page 27

	390	260
Approx. Pack size:	76cm x 30cm	76cm x 28cm
Approx. Weight:	21kg	18kg

Floor Plans

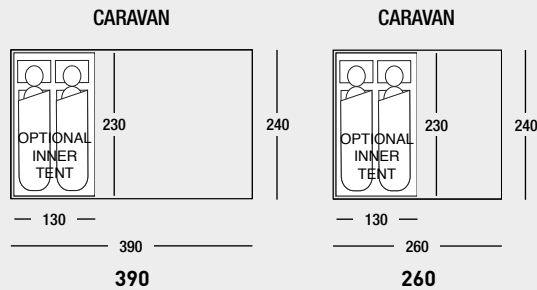

- Includes** Internal Roof bars **x2**
- Includes** Storm Buckles
- Includes** Draught Skirt

Our much loved Ultima models in SunnCamp's original profile/shape with enhanced headroom and living space.



ULTIMA CLASSIC 390

... enhanced headroom and living space.



ULTIMA CLASSIC 260

PROTEKTA - ROLL OUT SUN CANOPY

Features:

- Minimum front height approximately 190cm
- Approximate projection 218cm
- Front leg adjustable heights: 192cm/204.5cm/217cm/229.5cm
- Aluminium frame

Optional Extras

Roof support/leg pole (DT0092)

7' Front Wall and 2 x Side Wall fits 192cm/204.5cm height (SF7832)

7' Front Wall and 2 x Side Wall fits 217cm/229.5cm height (SF7833)

10' Front Wall and 2 x Side Wall fits 192cm/204.5cm height (SF7834)

10' Front Wall and 2 x Side Wall fits 217cm/229.5cm height (SF7835)

13' Front Wall and 2 x Side Wall fits 192cm/204.5cm height (SF7836)

13' Front Wall and 2 x Side Wall fits 217cm/229.5cm height (SF7837)

	7 Foot (SF7771)	10 Foot (SF7772)	13 Foot (SF7773)
Approx. Pack size:	110cm x 10cm x 20cm	162cm x 10cm x 20cm	208cm x 10cm x 20cm
Approx. Weight:	4.6kg	5.7kg	6.8kg

The Protekta Sun Canopy is designed for those who require a simple, easy to use, fair weather sunshade. The canopy simply unfolds from the protective bag, the frame attaches in position and after pegging the guy ropes, you are ready to start your holiday.

Optional
Roof
Support/Leg
Pole available
(DT0092)



... simple, easy to use ...



PROTEKTA - shown with Wall Pack

SWIFT CANOPY 390 (SF8000)

SWIFT CANOPY 330 (SF8004)

SWIFT CANOPY 260 (SF7690)

Features:

- Steel and fibreglass frame
- Side windows

Check out optional extras available on page 27

	390	330	260
Approx. Pack size:	79cm x 18cm	77cm x 15cm	76cm x 17cm
Approx. Weight:	7kg	5kg	6.4kg
Alu Roof Poles:	x 1	✗	✗

The perfect sun canopy - stylish and easy to set up! Now available in three sizes; 390, 330 and 260

Floor Plans

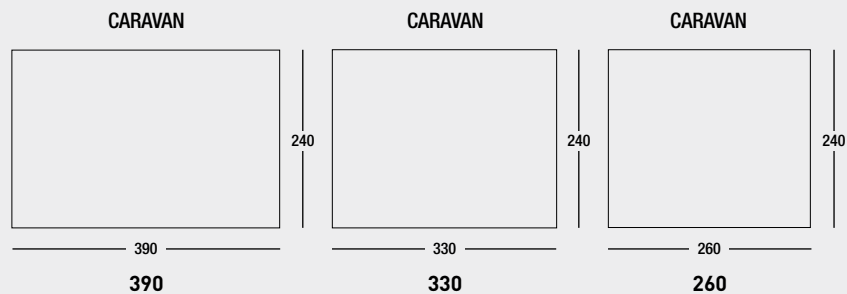

SWIFT CANOPY 390

... stylish and easy to set up!



SWIFT CANOPY 330

OPTIONAL EXTRAS - Poled Awnings

Model	Luxury Awning Carpet	Breathable Groundsheet	Rear Pad Poles	Canopy Pole Set	Roof Pole	Low Wall Set	High Wall Set	Roof Support Leg Pole	Awning Windbreak
Ultima 390 Classic	BC1008	DT0038	DT0052	DT0032	✓ Included	X	X	X	SF7838
Ultima 260 Classic	BC1004	DT0037	DT0052	DT0032	✓ Included	X	X	X	SF7838
Swift Deluxe 390	BC1008	DT0038	DT0052	DT0032	DT0091	X	X	X	SF7838
Swift Deluxe 325	BC1006	DT0053	DT0052	DT0032	DT0091	X	X	X	SF7838
Swift Deluxe 260	BC1004	DT0037	DT0052	DT0032	DT0091	X	X	X	SF7838
Swift Deluxe 220	BC1003	DT0046	DT0052	DT0032	DT0091	X	X	X	SF7838
Swift Canopy 390	BC1008	DT0038	X	X	DT0091	X	X	X	SF7838
Swift Canopy 330	BC1006	DT0053	X	X	DT0091	X	X	X	SF7838
Swift Canopy 260	BC1004	DT0037	X	X	X	X	X	X	SF7838
Protekta 7'	X	X	X	X	X	SF7832	SF7833	DT0092	SF7838
Protekta 10'	X	X	X	X	X	SF7834	SF7835	DT0092	SF7838
Protekta 13'	X	X	X	X	X	SF7836	SF7837	DT0092	SF7838

TOURER MOTOR AIR 335 PLUS (SF7863)

Features:

- Zipped rear access panel
- Access zip in rear tunnel
- Tunnel privacy screen
- Front panel with roll back doors
- SunnCamp's enhanced roof profile (ERP)
- Curtains on all windows
- Eyebrow porch
- Sewn in groundsheet
- Sleeps 2 with optional inner tent
- **Fits Motorhomes up to 270cm**
- **Pack size: 79 x 40cm/Weight: 22kg approx.**

Floor Plan

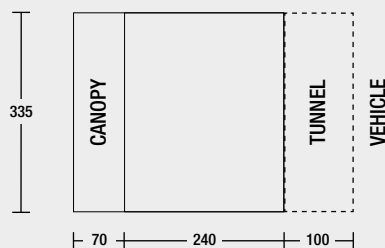

Optional Inner Tent Available (SF7716)

Includes Pump with gauge and dump valve 

Includes AIR Storm Bars **x4**

Includes Storm Buckles & Straps

Includes Figure of 8 Fixing 



... ideal for family or short stay holidays ...

Our bestselling Tourer model is ideal for family or short stay holidays and can be utilized with our optional two berth inner tent for storage or as an extra sleeping area.

The large front canopy provides protection to the front doorway panel and the front vented section/side window panels offer ventilation throughout.

IMPACT MOTOR AIR 350 (SF7864)

IMPACT MOTOR AIR 350 GRANDE (SF7865)

Features:

- Zipped rear access panel
- Access zip in rear tunnel
- Tunnel privacy screen
- Removable front panel with roll back half way option
- Large side window
- SunnCamp's enhanced roof profile (ERP)
- Curtains on all windows
- Sewn in groundsheet
- Internal divider curtain
- **Fits Motorhomes up to 270cm**
- **350 - Pack size: 77 x 37cm/Weight: 17kg approx.**
- **350 Grande - Pack size: 79 x 35cm/Weight: 20kg approx.**

Floor Plans

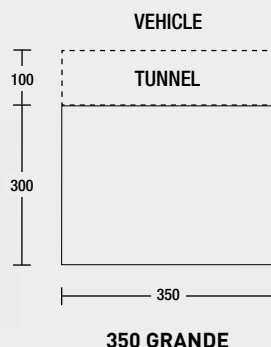
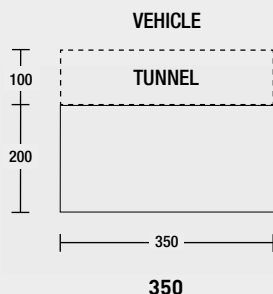

Includes Pump with gauge and dump valve

Includes AIR Storm Bars **x2** 350

Includes Aluminium Roof poles **x3** Grande

Includes Storm Buckles & Straps

Includes Figure of 8 Fixing



... includes SunnCamp's Tunnel Privacy Screen



Our Impact Motor 350 and 350 Grande model are manufactured using our **PRO-TEK 300D** fabric and have extra large windows and a removable front panel (with roll back option). Both models have zipped access in the tunnel for added convenience and include a tunnel privacy screen.

SWIFT VAN AIR 325 TALL (SF8014)

SWIFT VAN AIR 325 LOW (SF8013)

Features:

- Wheel chair access
- Air flow doorways
- Zipped rear access panel
- Curtains on all windows
- Tunnel privacy screen
- Sewn in groundsheet
- Central clip privacy curtain
- **Fits Motorhomes Tall: 240cm – 270cm /Low 180cm – 210cm**

Wheel chair
Access

Floor Plan

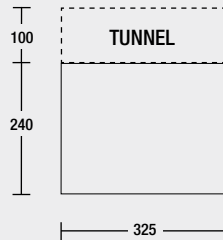

Created and designed based on our hugely successful range of Swift Air caravan awnings, our SWIFT VAN AIR awnings are easy to erect, stylish and fantastic value for money.

Available in a 'Tall' and 'Low' tunnel height with airflow doorways and a roll up front door with canopy option.

Includes Pump with gauge and dump valve



Includes AIR Storm Bars x3



Includes Storm Buckles & Straps



Includes Figure of 8 Fixing



SWIFT VAN AIR 325

... easy to erect, stylish and fantastic value ...



SWIFT VAN AIR 325 - poled and air versions

SILHOUETTE MOTOR AIR 225 PLUS (SF7866)

SILHOUETTE MOTOR AIR 250 GRANDE (SF7867)

Features:

- Zipped rear access panel
- Access zip in rear tunnel
- Tunnel privacy screen
- Extra wide roll back front door
- 225 Plus Model – large side window
- 250 Grande Model – large side door with window and canopy option
- Eyebrow porch
- SunnCamp's enhanced roof profile (ERP)
- Curtains on all windows
- Sewn in groundsheet
- **Fits Motorhomes up to 240cm**
- **225 - Pack size: 74 x 32cm/Weight: 10kg approx.**
- **250 Grande - Pack size: 78 x 34cm/17kg approx.**

Floor Plans

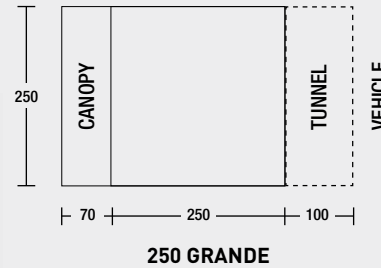
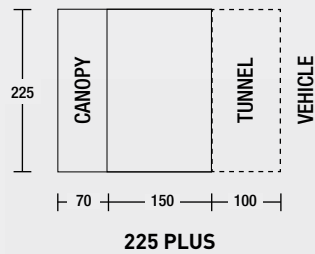

Includes Pump
with gauge and dump valve 

Includes AIR Storm Bars **x1** **225**

Includes AIR Storm Bars **x3** **250**

Includes Storm Buckles & Straps

Includes Figure of 8 Fixing **∞**



Both models are small, compact and ideal for people who require a straightforward uncomplicated inflatable motor annexe. The Silhouette has plenty of features including an extra wide front door, eyebrow porch and sewn in groundsheet.

ULTIMATE MOTOR AIR 300 (SF7871)

Compatible with **MOTOR ANNEXE** (SF7869)

Features:

- Single inflation
- Three zip out side panels with large window and roll back door (with secondary mesh)
- Access zip in rear tunnel
- Tunnel privacy screen
- SunnCamp's enhanced roof profile (ERP)
- Curtains on all windows
- Sewn in groundsheet
- Optional annexe - (fits on all 3 sides)
- Zipped rear access
- **Fits Motorhomes up to 260cm**
- **300 - Pack size: 79 x 37cm/Weight: 19kg approx.**
- **Annexe - Pack size: 70 x 22cm/Weight: 8kg approx.**

Our ULTIMATE MOTOR AIR 300 is a single inflation point awning and optional bedroom annexe(s) can be fitted into three of the awnings panels offering great flexibility to arrange your awning as required. SunnCamp's **300D PRO-TEK** fabric is used to enhance this brilliant awning.

Floor Plan

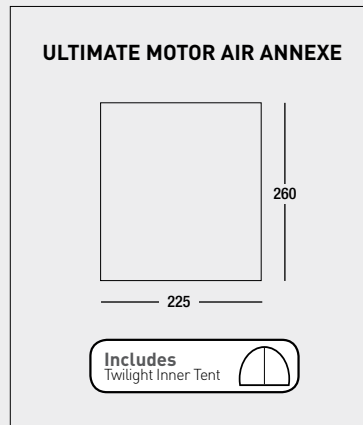
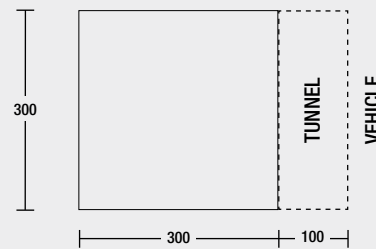

Includes Pump
with gauge and dump valve 

Includes Storm Buckles & Straps 

Includes Figure of 8 Fixing 



Offering great flexibility to arrange your awning as required



TOURER 335 MOTOR PLUS TALL (SF8012)

TOURER 335 MOTOR PLUS LOW (SF8011)

Features:

- Wheel chair access
- Zipped rear access panel
- Access zip in rear tunnel
- Tunnel privacy screen
- Front panel with roll back doors
- Curtains on all windows
- Eyebrow porch
- Sewn in groundsheet
- Access zip in rear tunnel
- Sleeps 2 with optional inner tent
- Steel and fibreglass frame
- **Fits Motorhomes: Tall: 240cm - 270cm Low: 180cm - 210cm**
- **Pack size: 28 x 84cm/Weight 19kg approx.**

Floor Plan

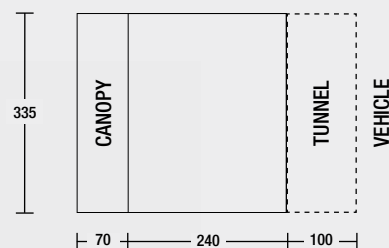

Optional
inner tent
available
(SF7716)

Includes
Storm Buckles 

Includes
Figure of 8 Fixing 

Side door
with
wheel chair
access



The Tourer
is ideal for
family or
short stay
holidays ...



Our bestselling Tourer model is now available in two heights for 2018 and now has a side door with wheel chair access.

The Tourer is ideal for family or short stay holidays and can be utilized with our optional two berth inner tent for storage or as an extra sleeping area.

The large front canopy provides protection to the front doorway panel and the front vented section/side window panels offer ventilation throughout.

SWIFT VAN 325 TALL (SF8045)

SWIFT VAN 325 LOW (SF8044)

Features:

- Wheel chair access
- Airflow doorways
- Zipped rear access panel
- Curtains on all windows
- Tunnel privacy screen
- Sewn in groundsheet
- Central clip privacy curtain
- **Fits Motorhomes: Tall: 240cm – 270cm**
Low: 180cm – 210cm



Floor Plan

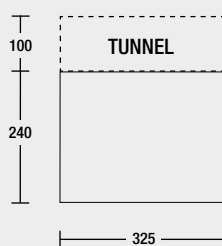

Includes Storm Buckles 

Includes Figure of 8 Fixing 

Includes Roof Poles  x1

Created and designed, based on our hugely successful range of Swift Deluxe caravan awnings, our SWIFT VAN awning is easy to erect, stylish and fantastic value for money.

Available in a 'Tall' and 'Low' tunnel height with airflow doorways and a roll up front door (with canopy option) this new motorhome awning for 2018 is sure to be a firm favourite!



SILHOUETTE 225 MOTOR PLUS (SF7870)

Features:

- Large side window
- Zipped rear access panel
- Extra wide roll back front door
- Eyebrow porch
- Tunnel privacy screen
- Sewn in groundsheet
- **Fits up to 240cm**
- **225 Plus - Pack size: 74cm x 23cm x 23cm approx. Weight 9kg approx.**

Floor Plan

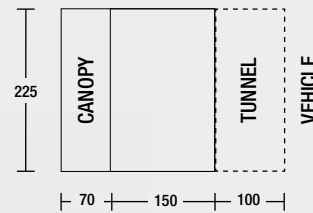

Includes Storm Buckles 

Includes Figure of 8 Fixing 

Compact and ideal for people who require a straightforward uncomplicated motor annexe. The Silhouette has plenty of features including an extra wide front door, large side window, eyebrow porch and sewn in groundsheet.



SILHOUETTE 225 MOTOR PLUS



Large side window with ventilation

The Silhouette has plenty of features ...



MOTOR BUDDY 300XL (SF8015)

MOTOR BUDDY 250 (SF7777)

Features:

- Curtains on all windows
- Zipped rear access panel
- Side panels include half window half mesh ventilation
- Fibreglass frame
- 300 XL model – integral annexe with inner tent included
- **Fits Motorhomes up to 240cm**
- **250 model - Pack size: 19cm x 76cm/ Weight 7.8kg approx.**
- **300XL model - Pack size: 77cm x 26cm/ Weight: 15.1kg approx.**

The success of our Motor Buddy drive away motor awning continues and for 2018 it is now available in two sizes, the original 250 and the all new 300XL model. Both offer similar features however the 300XL comes with a fixed annexe which is ideal for sleeping or extra storage.

Floor Plans

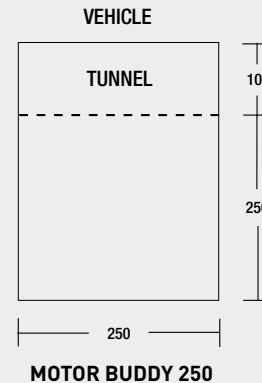
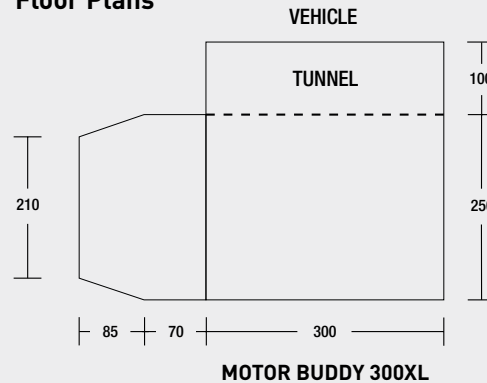

Includes Figure of 8 Fixing 



... our new 300XL model comes with a fixed annexe which is ideal for sleeping or extra storage

LODGE 200 MOTOR (SF7776)

Features:

- Roll up front door with canopy option (poles optional extra)
- Sewn in groundsheet
- Curtains on all windows
- Side window with ventilation
- Fibreglass frame
- **Fits Motorhomes up to 240cm**
- **Pack size: 20 x 69cm/Weight 8.1kg approx.**

Floor Plan

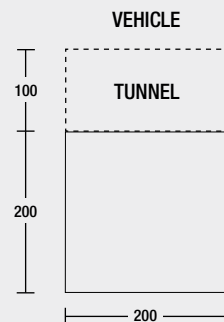

Includes Figure of 8 Fixing 



SWIFT VAN CANOPY 260 (SF8016)

Features:

- Dual beading 6.2mm/4mm
- Steel and fibreglass frame
- Side windows
- **Fits Vans 180cm – 210cm**
- **Pack size: 77cm x 15cm approx. Weight: 5kg approx.**

Floor Plan

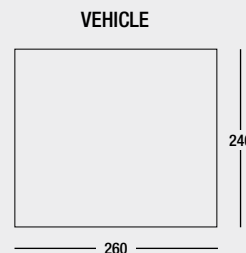

Designed for low type vehicles, our new Swift Van Canopy may not be a drive away but its quick pitch and removal makes it an ideal fair weather shelter at a fantastic price!



OPTIONAL EXTRAS – Air Volution Motor Awnings and Poled Motor Awnings

Air Volution Motor Awnings

Model	Luxury Carpet	Footprint Groundsheet	Additional Air Storm Bars	Canopy Pole Set	Annexe	Inner Tent	Drive Away Awning Kit
Tourer 335 Motor Air	CC1160	FC1057	SF7851 (2 pieces)	N/A	N/A	SF7716	DT0084
Impact Motor Air 350	CC1169	FC1070	N/A	N/A	N/A	N/A	DT0084
Impact Motor Air 350 Grande	CC1175	FC1076	N/A	N/A	N/A	N/A	DT0084
Swift Van Air 325 Tall & Low	N/A	N/A	N/A	DT0032	N/A	N/A	DT0084
Silhouette Motor Air 225 Plus	CC1139	FC1058	N/A	N/A	N/A	N/A	DT0084
Silhouette Motor Air 250 Grande	CC1184	FC1077	N/A	DT0032	N/A	N/A	DT0084
Ultimate Motor Air 300	CC1176	FC1078	N/A	N/A	SF7869	N/A	DT0084

Poled Motor Awnings

Model	Luxury Carpet	Footprint Groundsheet	Additional Storm Bars	Canopy Pole Set	Annexe	Inner Tent	Drive Away Awning Kit
Tourer 335 Motor Plus	CC1160	FC1057	N/A	N/A	N/A	SF7716	DT0084
Swift Van 325	N/A	N/A	N/A	DT0032	N/A	N/A	DT0084
Silhouette Motor 225 Plus	CC1139	FC1058	N/A	N/A	N/A	N/A	DT0084
Motor Buddy 300XL	N/A	N/A	N/A	DT0032	N/A	N/A	DT0084
Motor Buddy 250	N/A	DT0056	N/A	DT0032	N/A	N/A	DT0084
Lodge 200 Motor	N/A	N/A	N/A	DT0032	N/A	N/A	DT0084
Swift Van Canopy	N/A	N/A	N/A	N/A	N/A	N/A	DT0084

SHADOW AIR 800 (SF7881)

Features:

- Twilight inner tents
- Airflow doorways
- Curtains on all windows
- Sewn in groundsheet
- **Centre height: 220cm**
- **Pack size: 79 x 41cm/
Weight: 23kg approx.**

Floor Plan

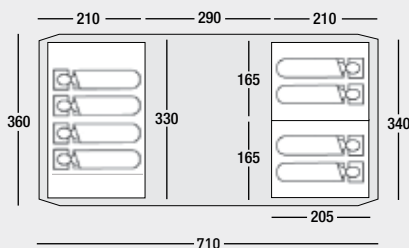

... a superior family air tent ...



Available Optional Extras:	
Footprint Groundsheet	FC1083
Luxury Carpet	CC1181
Air Roof Bar Set	SF7897

Our Shadow 800 boasts all the advantages of a vis a vis designed tent as well as incorporating SunnCamp's Air Volution Technology consequently offering a superior family air tent at an affordable price.

Includes Pump with gauge and dump valve 

Includes Storm Buckles & Straps 

Includes Twilight Inner Tent 



SPECTRE 800 [SF1308] SPECTRE 600 [SF1309] & EXTENSION [SF1310]

Features:

- Roll up door with canopy option (poles optional extra)
- Airflow doorways
- Curtains on all windows
- Twilight inner tents
- Sewn in groundsheet (800 and 600 models)
- Loose groundsheet (extension)
- Fibreglass frame
- **Centre Height 220cm/Extension 210cm**
- **800 - Pack size: 76 x 38cm/Weight 24kg approx.**
- **600 - Pack size: 75 x 36cm/Weight 21kg approx.**
- **Optional Extension - Pack size: 70 x 17cm/Weight 8kg approx.**

Available Optional Extras:	800	600
Footprint Groundsheet	FC1051	FC1052
Luxury Carpet	CC1154	CC1173
Canopy Pole Set	DT0032	DT0032

Floor Plan

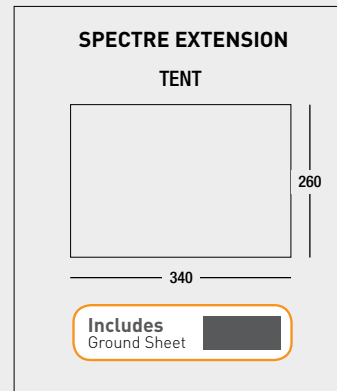
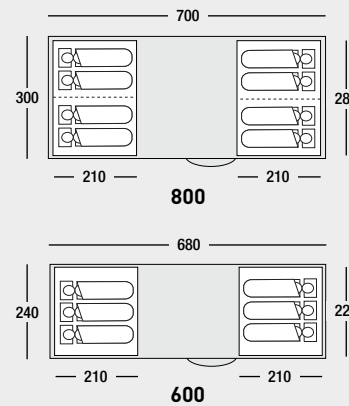

Ideal for medium to large family holidays ...

Ideal for medium to large family holidays and compatible with our optional Spectre Extension should you require extra space/living room. (800 model shown)



SILHOUETTE 400 (SF7882)
SILHOUETTE 200 (SF1329)

Features:

- Extra wide front door
- Pre-fitted twilight inner tent
- Curtains on all windows
- Sewn in groundsheet
- Eyebrow porch
- Steel and fibreglass frame
- 400 model only – Side door with large window (roll up or canopy option)
- 400 model only – Integral zip away front canopy
- **Centre height: 200 model: 220cm: 400 model: 200cm**
- **400 - Pack size: 79 x 32cm/Weight: 16kg approx.**
- **200 - Pack size: 65 x 24cm/Weight: 11kg approx.**

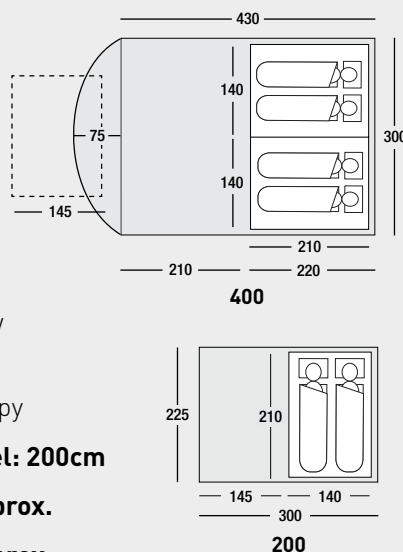
Floor Plan



- Includes Storm Buckles 
- Includes Twilight Inner Tent 

Available Optional Extras:	400	200
Footprint Groundsheet	FC1085	FC1039
Luxury Carpet	CC1183	CC1139
Canopy Pole Set	DT0032	N/A



SILHOUETTE 400

... both models come with pre-fitted inner tents, making set up easy ...



SILHOUETTE 200

Our Silhouette 200 model is perfect for the single camper or a couple whilst our Silhouette 400 model is perfect for a couple or a small family looking to go away on a camping holiday. Both models offer standing height and come with pre-fitted inner tents, making set up simple.

The Silhouette 400 additionally comes with a built in front canopy that offers protection from rain when entering your tent and a side door with large window.

UTILITY LODGE

[SF3032]



Features:

- Includes groundsheet
- Roll up front panel
- Rear vented panel
- Steel frame
- **Size: 210 x 140 x 210hcm approx.**
- **Pack size: 109 x 14cm**
- **Weight: 8.4kg approx.**



UTILITY BUDDY

[SF3031]



Features:

- Side panels include half window half ventilation
- Handy storage pockets
- Fibreglass frame
- **Size: 250 x 250 x 210hcm approx.**
- **Pack size: 74 x 17cm/Weight: 6.8kg approx.**



WINDJAMMER

[SF3005 BLUE] [SF3029 GREY]
[SF3025 FERN]



Available
in 3
colour ways

Features:

- Steel poles
- **Size: 500 x 140cm approx.**
- **Pack size: 56 x 9cm**
- **Weight: 2.5kg approx.**



VERANO DL UNIVERSAL EXTENSION

[SF1186 GREY] [SF1187 BLUE] [SF1353 FERN]



Features:

- Front door rolls to the side
- Removable front panel
- Steel frame
- **Size: 345 x 185 x 210hcm approx.**
- **Pack size: 71 x 23cm/Weight: 13kg approx.**

Available
in 3
colour ways



GLOSSARY

Non standard specification/features:

Storm pole pocket:

Certain models have an integral storm pole pocket and when used in conjunction with our optional upright poles (DT0052) can be used in certain conditions to aid stability and help water dispersal. Check individual entries for details.

Air flow doorway:

A separate ventilated mesh panel incorporated behind a door panel. This can be rolled back or zipped in place to aid airflow and reduce condensation whilst keeping bugs out. Check individual entries for details.

Sewn in groundsheet:

All tents and certain motor awnings models come with a sewn in groundsheet system offering protection from insects, dust, the elements etc. Check individual entries for details.

Veranda option:

Certain awnings come with a veranda option which allows you to fold the panel of your awning over a veranda pole to give a veranda effect. Simply locate the veranda pole (DT0091) in the pockets in the relevant panel. Check individual entries for details.

Storm buckles and straps:

Storm buckles and straps are provided as standard on all air evolution models.

Window lights:

Certain awnings come with windows in the roof with velcro fastening curtains to enhance the light inside your awning. Check individual entries for details.

Enhanced Roof Profile:

SunnCamp's Enhanced Roof Profile is utilized on caravan awnings and motor awnings manufactured in our 300D Pro-Tek fabric, further complementing the appearance and providing a homely ambience.

Privacy Screen:

Many of our motor awnings come as standard with a simple divider for the tunnel area which may be attached to divide the tunnel to offer privacy. Check catalogue entry for details.

Standard specification/features:

Waterproof flysheet:

6000MM HH (except Protekta range). All flysheets comply with the latest British Standard Flame Retardant Regulations.

Taped seams:

Main seams have been heat sealed with a polyurethane tape to give extra waterproof protection. Remaining seams and seams where tape has been broken during production and/ or to necessitate tie points, suspension points etc., should have seam sealant applied to them.

Zips:

Heavy duty SunnCamp zips are used throughout our range of products.

Windows:

All windows have curtains with velcro or toggle fixings.

Colour coded poles and sleeves:

Where a product has different length poles, to aid setup our poles and sleeves are colour coded.

Rear pads:

SunnCamp porch awnings come as standard with rear weather pads. Rear weather pad poles are not standard – please check individual entry for details.

Draught skirt:

A PVC or PE draught skirt (varies over models) is included as standard with all porch awnings (except Swift Canopy and Protekta models).

Figure of 8:

Supplied as standard on all motor awnings.

Daylight panel:

Where necessary tents have been designed with a daylight panel (light colour fabric over the living area) enhancing light access.

Cable entry point and tidy system:

All tents come with a zipped entrance allowing a mains lead to run safely into your tent. The cable tidy system which consists of velcro fastening points allows the cable from a mains powered light to be stored safely.

Twilight Inner Tents:

Where inner tents are provided, they have been darkened for extra comfort.





SunnCamp



ICON AIR size 11 - internal view

SunnCamp Dealer/Stockist:

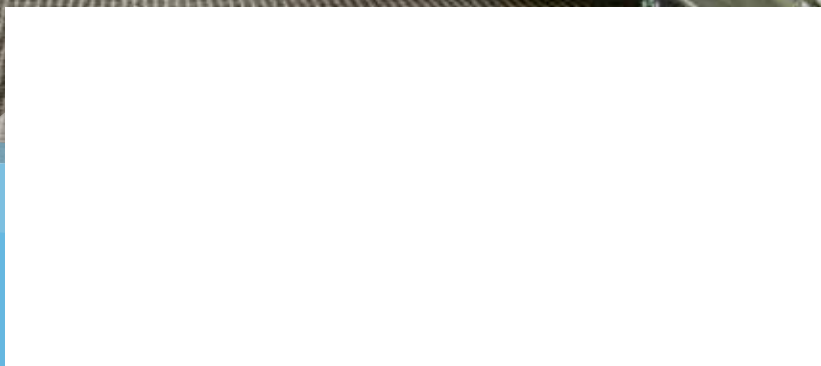

SunnCamp UK
www.sunncamp.co.uk

The weights, sizes, plans and colours shown in this brochure are given as an indication and are approximate. SunnCamp reserve the right to alter specifications as considered necessary without notice.

ICON AIR®